

ANGLE-TOP BOTTOM-UP SHADES

A.) Standard corded Bottom-Up w/Rigid Hem

Shade is fully retractable. But does not cover the angled part of the window when up.

A.)

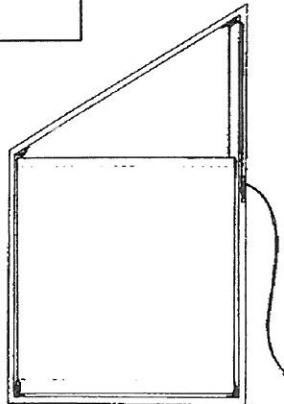

B.) Corded Bottom-Up Angle-Top w/ Rigid Hem

Shade covers the window when up but is not fully retractable.

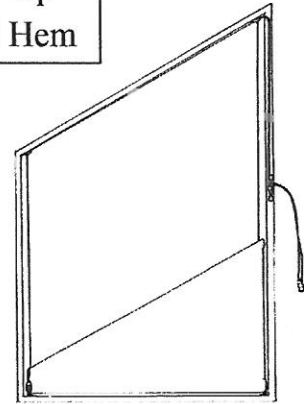

C.) Corded Bottom-Up Angle-Top w/ Soft Hem

Shade covers the window and is fully retractable. Cords are visible in the windows when shade is down.

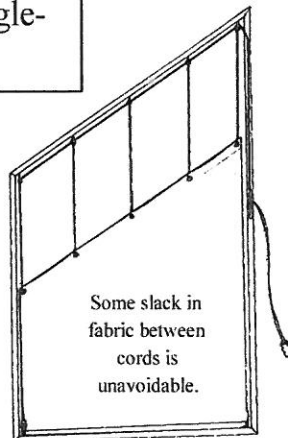

D.) Bottom-Up Triangle w/ Soft Hem

Shade covers the window and is fully retractable. Cord is visible in the window when shade is down.

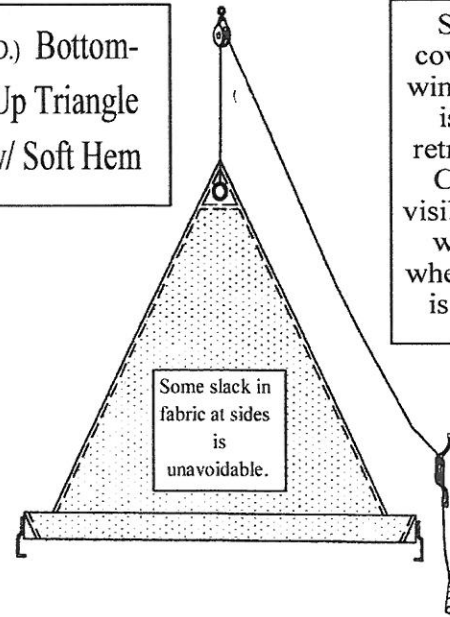

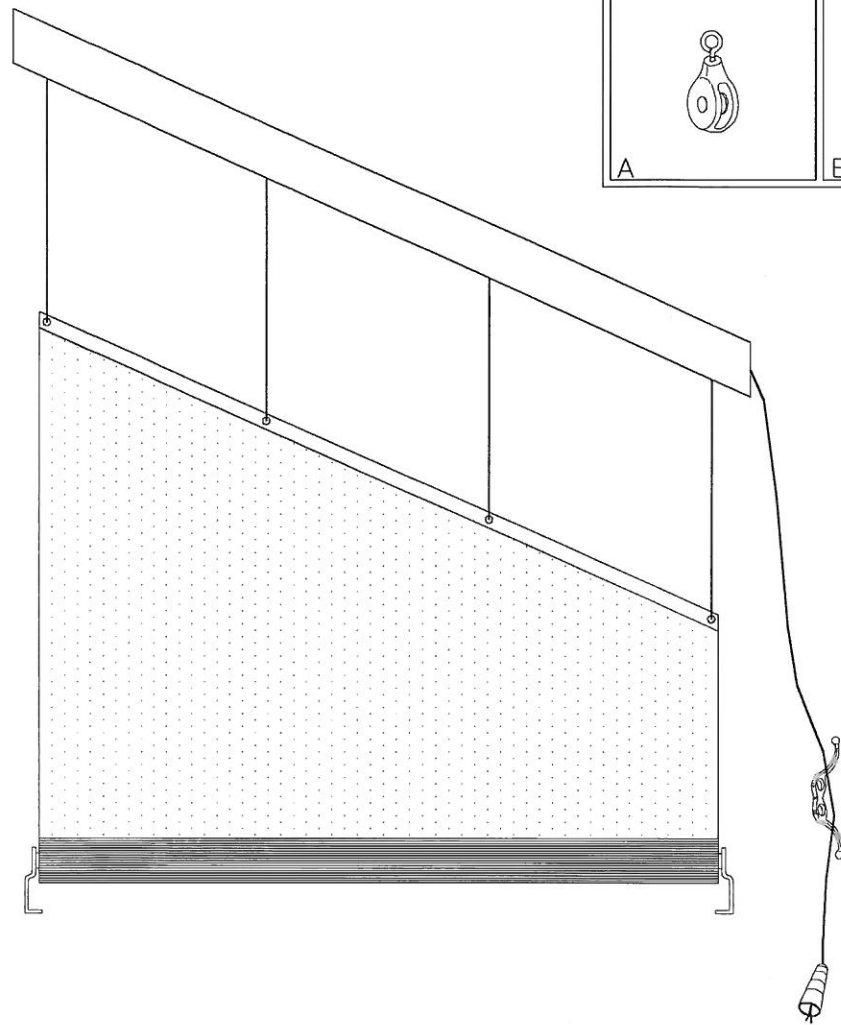
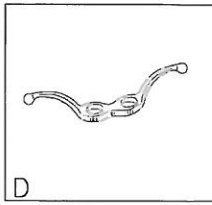
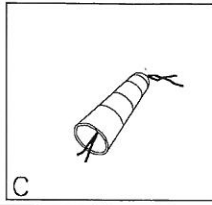
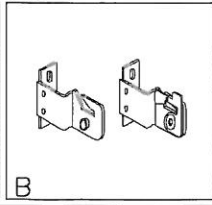
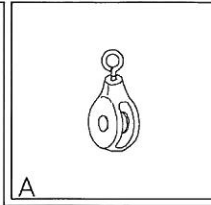

KEY

A. Pulley
 B. Locking brackets
 C. Cord pull
 D. Cleat

Bottom-Up Trapezoidal Shade

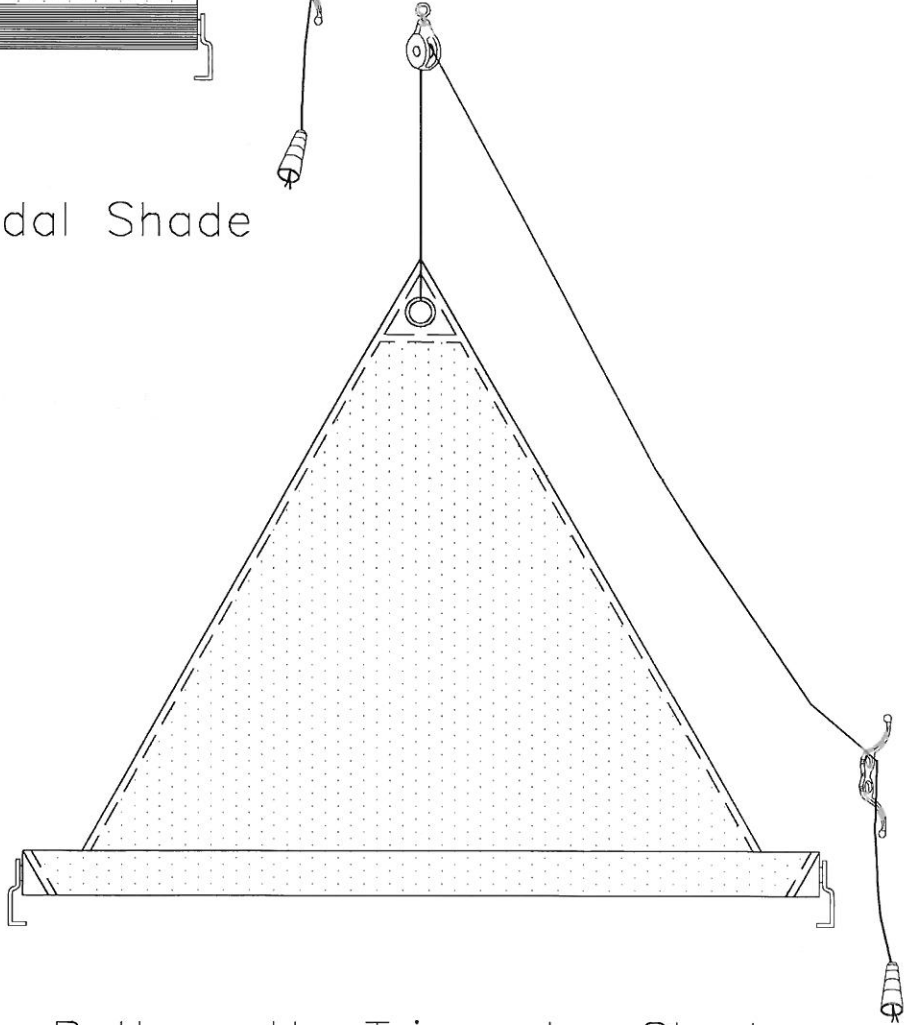

Bottom-Up Triangular Shade

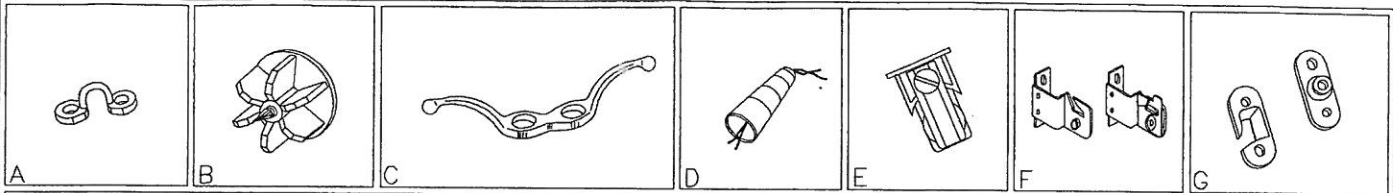

Corded Bottom-Up Shade

